

Ground Floor

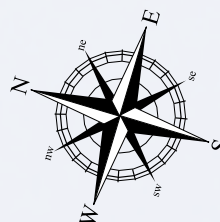
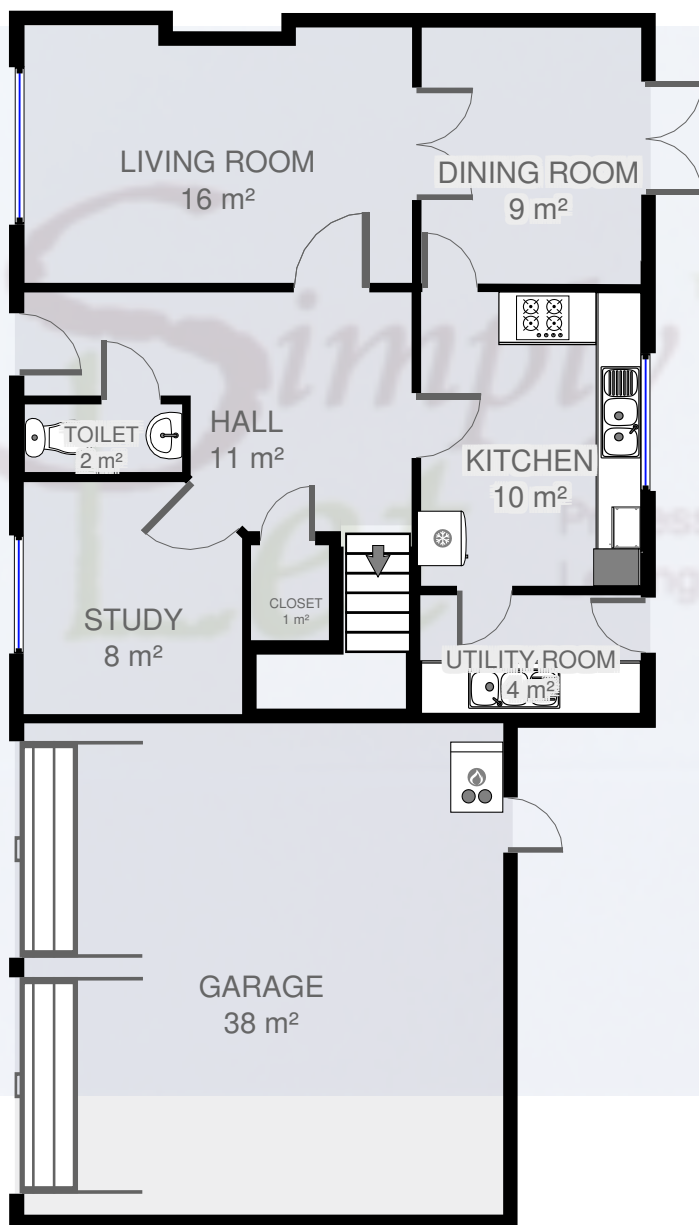

Although care has been taken in surveying the subjects for the production of this plan it's accuracy cannot be guaranteed and it should be regarded as indicative only and should not be relied upon for measuring purposes. Room contents and fittings are for illustration only and do represent the actual contents.

Plan 66

32 Redwood Avenue, Milton of Leys, Inverness, IV2 6HA



J R Gell MRICS
john.gell@simplylet.biz
01463 718888
2014-10-21 11:58

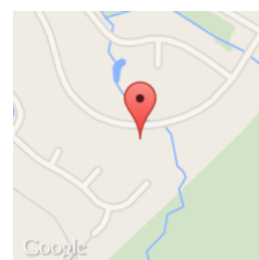

Kitchen

Width: 2.79 m Length: 3.73 m
 Area: 10 m² Perimeter: 13.04 m
 Ceiling Height: 2.60 m

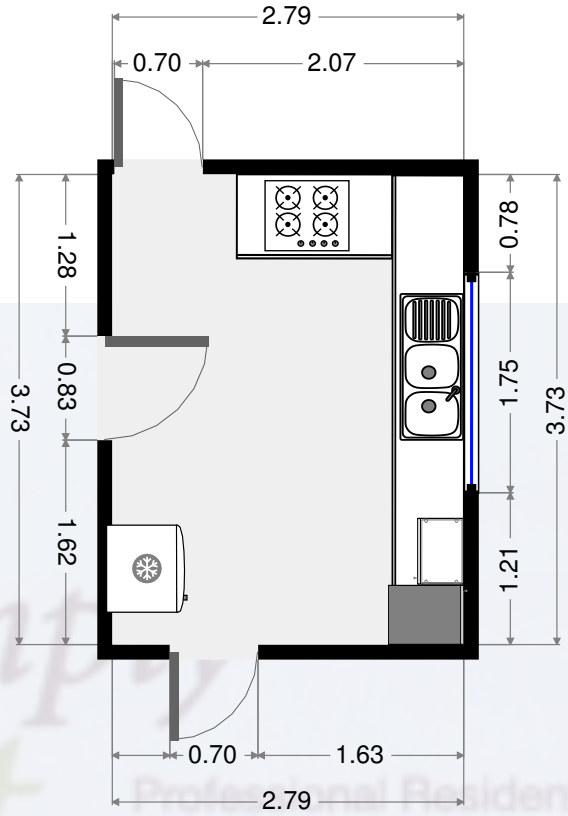
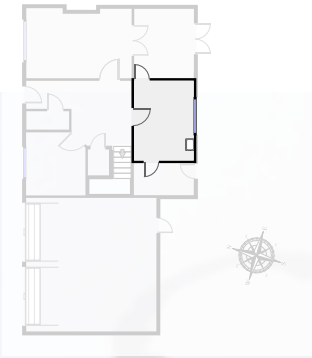

Dining Room

Width: 2.79 m Length: 3.25 m
 Area: 9 m² Perimeter: 12.12 m
 Ceiling Height: 2.60 m

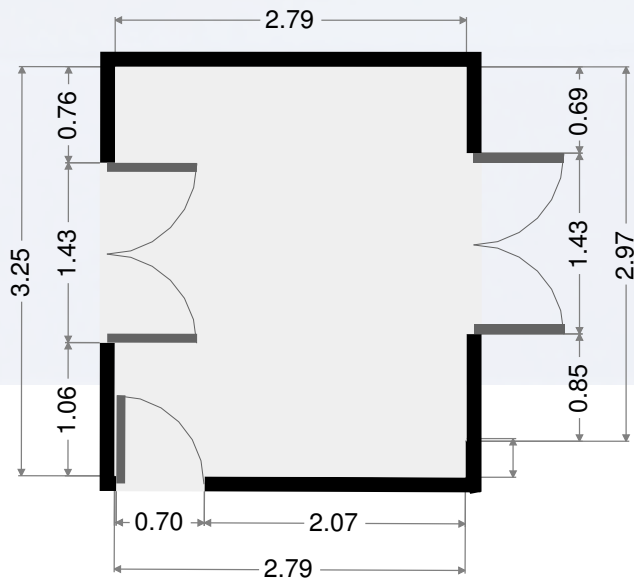
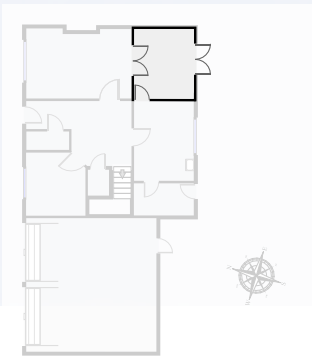

Although care has been taken in surveying the subjects for the production of this plan it's accuracy cannot be guaranteed and it should be regarded as indicative only and should not be relied upon for measuring purposes. Room contents and fittings are for illustration only and do represent the actual contents.



Plan 66

J R Gell MRICS
 john.gell@simplylet.biz
 01463 718888
 2014-10-21 11:58

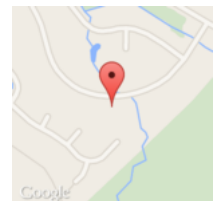

Living Room

Width: 3.27 m Length: 4.92 m
 Area: 16 m² Perimeter: 16.86 m
 Ceiling Height: 2.60 m

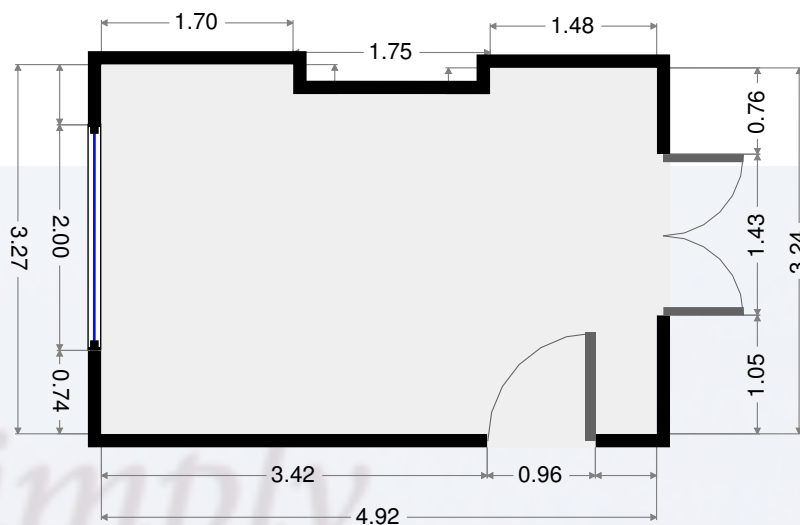
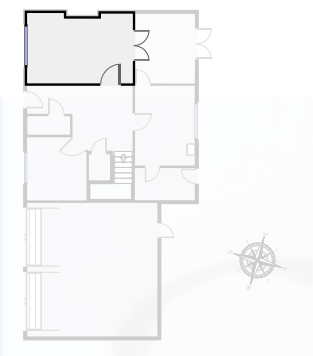

Hall

Width: 3.03 m Length: 4.92 m
 Area: 11 m² Perimeter: 15.48 m
 Ceiling Height: 2.60 m

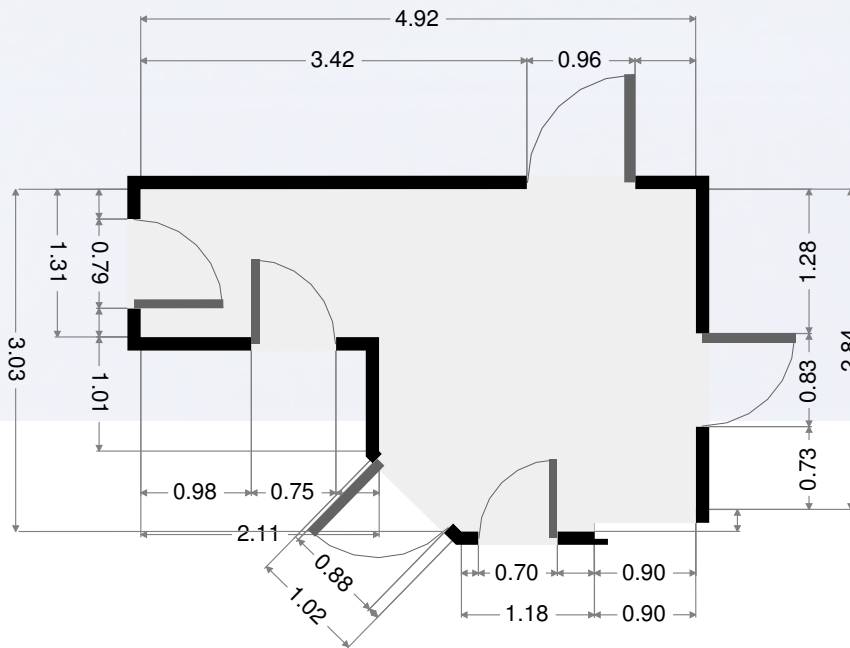
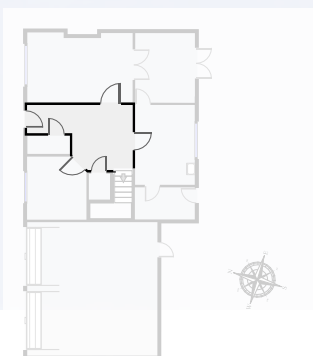

Simply Let
 Professional Residential
 Letting Specialists

Although care has been taken in surveying the subjects for the production of this plan it's accuracy cannot be guaranteed and it should be regarded as indicative only and should not be relied upon for measuring purposes. Room contents and fittings are for illustration only and do represent the actual contents.



Plan 66

J R Gell MRICS
 john.gell@simplylet.biz
 01463 718888
 2014-10-21 11:58

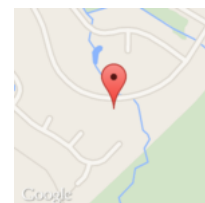

Study

Width: 2.77 m Length: 2.95 m
 Area: 8 m² Perimeter: 11.02 m
 Ceiling Height: 2.60 m

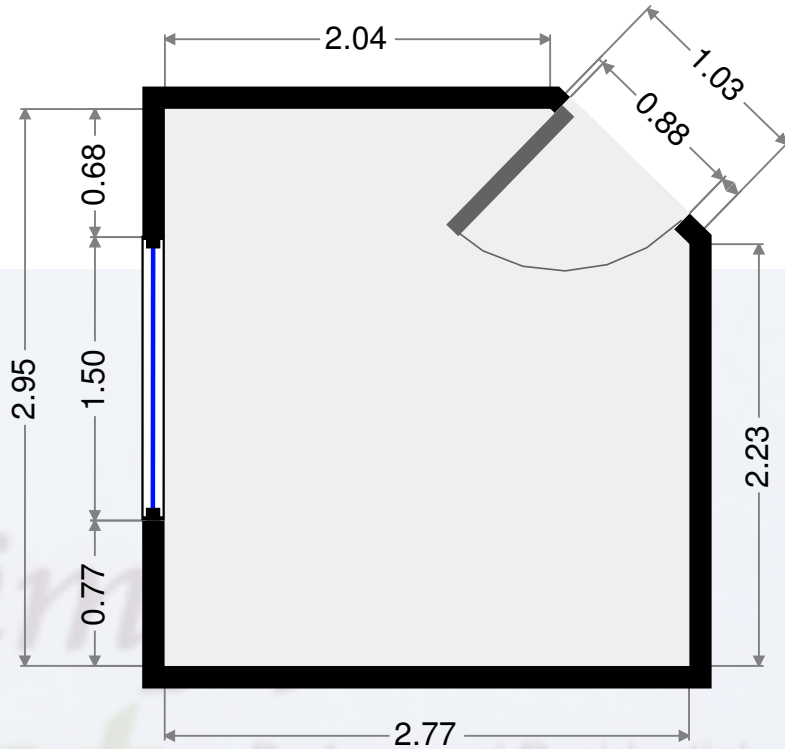
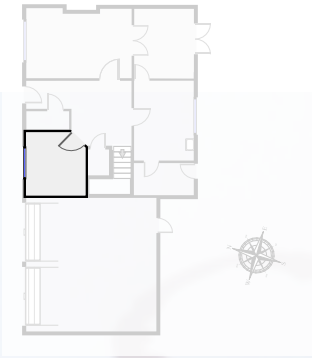

Utility Room

Width: 1.50 m Length: 2.80 m
 Area: 4 m² Perimeter: 8.60 m

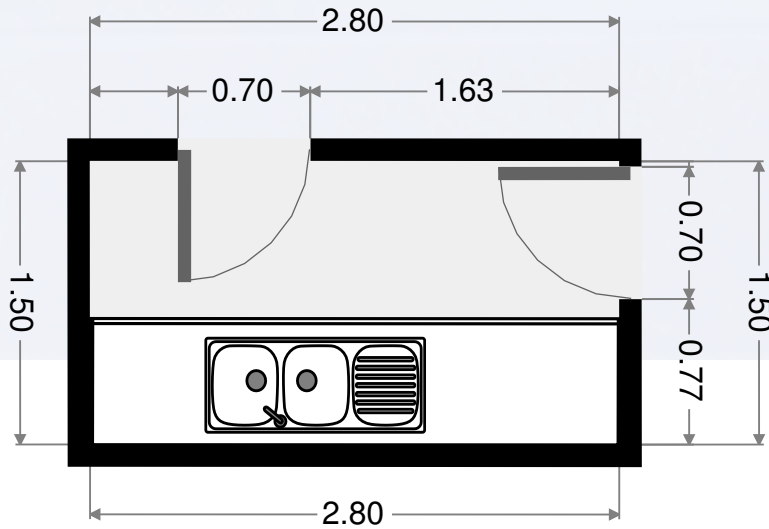
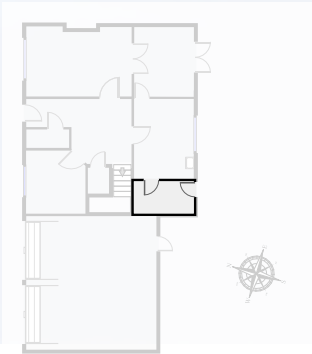

Although care has been taken in surveying the subjects for the production of this plan it's accuracy cannot be guaranteed and it should be regarded as indicative only and should not be relied upon for measuring purposes. Room contents and fittings are for illustration only and do represent the actual contents.



Plan 66

J R Gell MRICS
 john.gell@simplylet.biz
 01463 718888
 2014-10-21 11:58

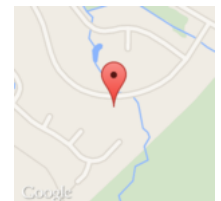

Closet

Width: 0.99 m Length: 1.21 m
Area: 1 m² Perimeter: 4.39 m

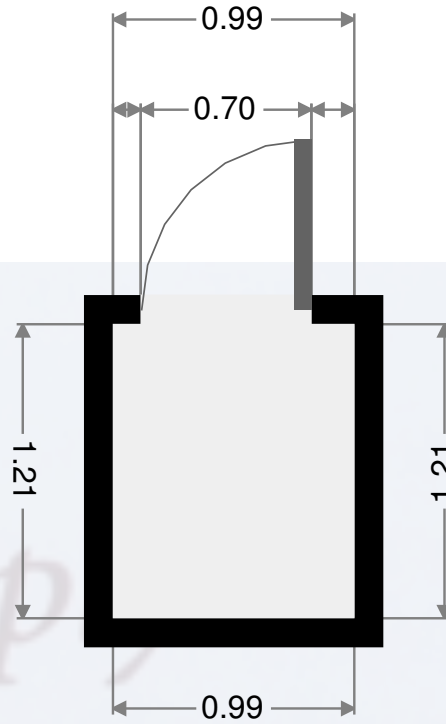
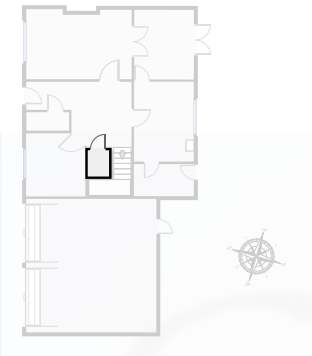

Toilet

Width: 0.86 m Length: 2.00 m
Area: 2 m² Perimeter: 5.72 m

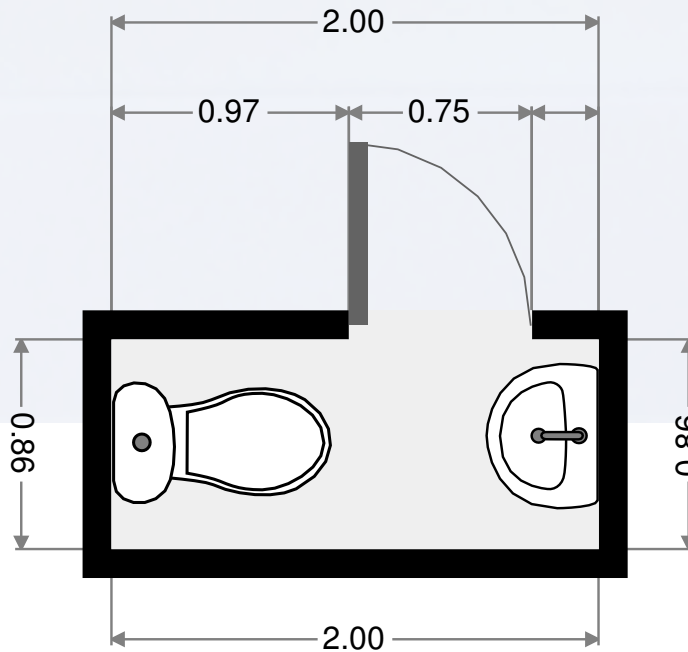
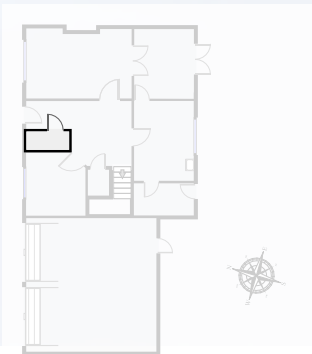

Although care has been taken in surveying the subjects for the production of this plan it's accuracy cannot be guaranteed and it should be regarded as indicative only and should not be relied upon for measuring purposes. Room contents and fittings are for illustration only and do represent the actual contents.

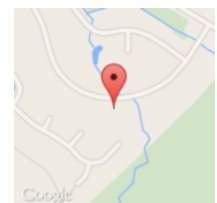

Garage

Width: 6.08 m

Length: 6.24 m

Area: 38 m²

Perimeter: 24.65 m

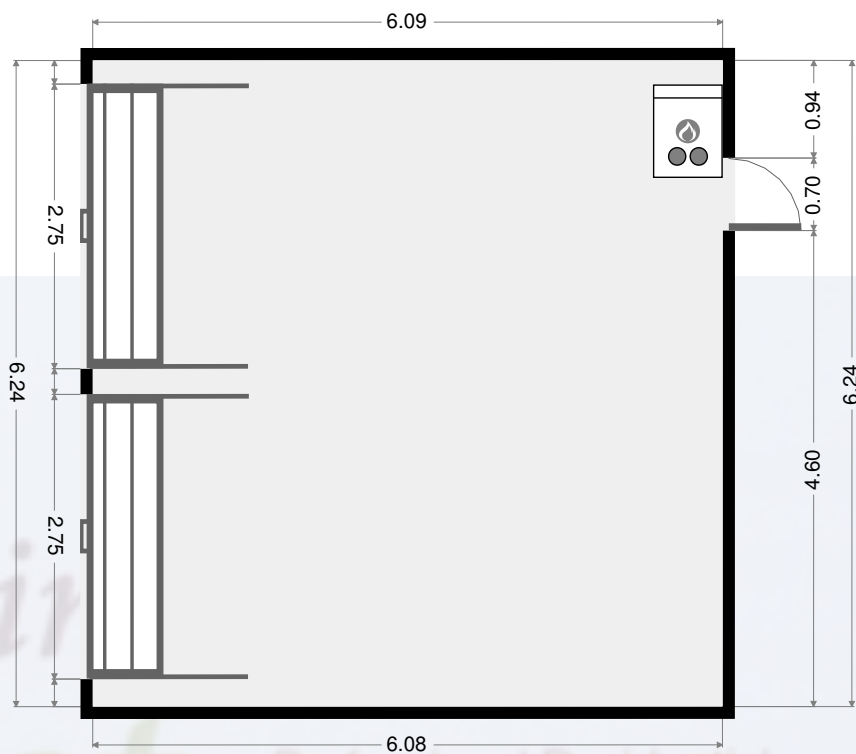
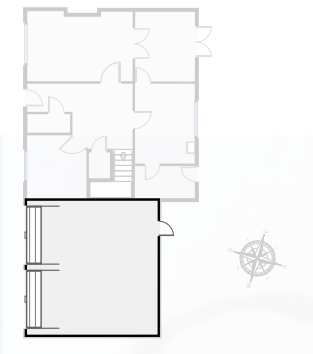

Simply Let
Professional Residential Letting Specialists

Although care has been taken in surveying the subjects for the production of this plan it's accuracy cannot be guaranteed and it should be regarded as indicative only and should not be relied upon for measuring purposes. Room contents and fittings are for illustration only and do represent the actual contents.

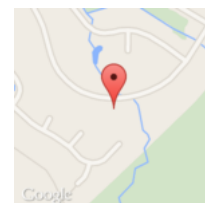

1st Floor

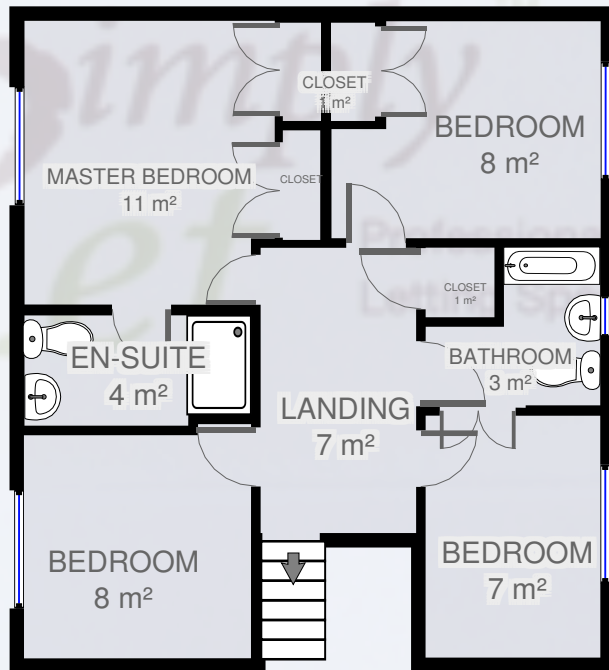

Although care has been taken in surveying the subjects for the production of this plan it's accuracy cannot be guaranteed and it should be regarded as indicative only and should not be relied upon for measuring purposes. Room contents and fittings are for illustration only and do represent the actual contents.

Plan 66

32 Redwood Avenue, Milton of Leys, Inverness, IV2 6HA



J R Gell MRICS
john.gell@simplylet.biz
01463 718888
2014-10-21 11:58

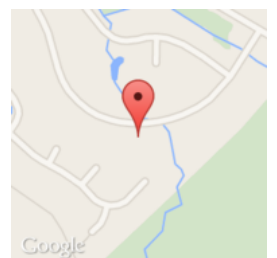

Landing

Width: 1.98 m Length: 3.62 m
 Area: 7 m² Perimeter: 11.20 m
 Ceiling Height: 2.60 m

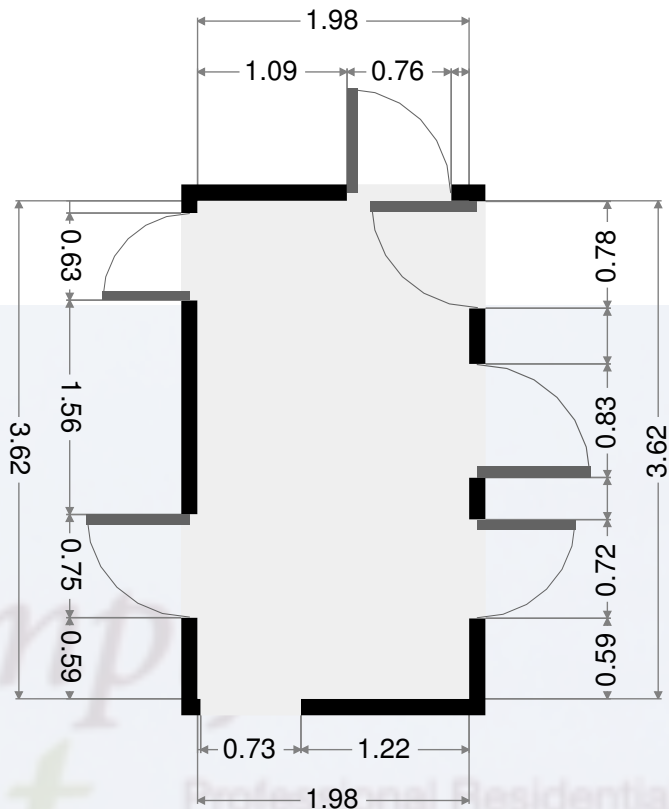
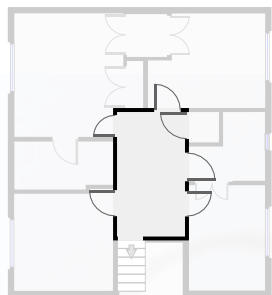

Bedroom

Width: 2.88 m Length: 2.97 m
 Area: 8 m² Perimeter: 11.72 m
 Ceiling Height: 2.60 m

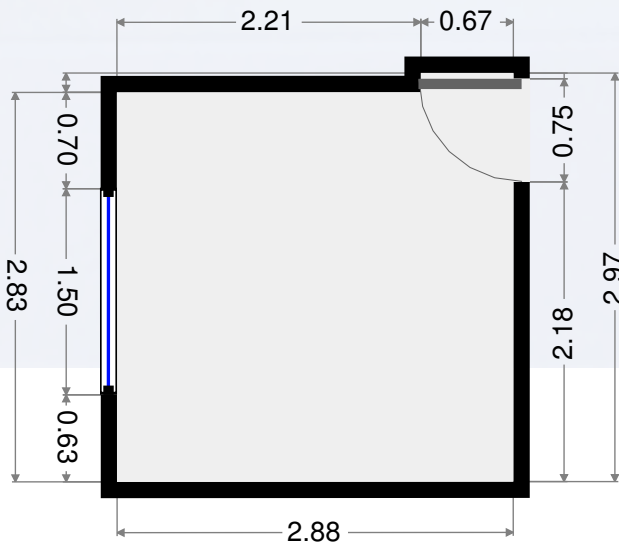
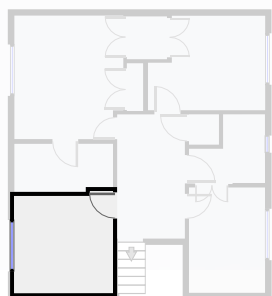

Although care has been taken in surveying the subjects for the production of this plan it's accuracy cannot be guaranteed and it should be regarded as indicative only and should not be relied upon for measuring purposes. Room contents and fittings are for illustration only and do represent the actual contents.

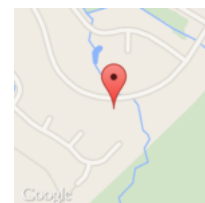

Master Bedroom

Width: 3.18 m Length: 3.60 m
 Area: 11 m² Perimeter: 13.57 m
 Ceiling Height: 2.60 m

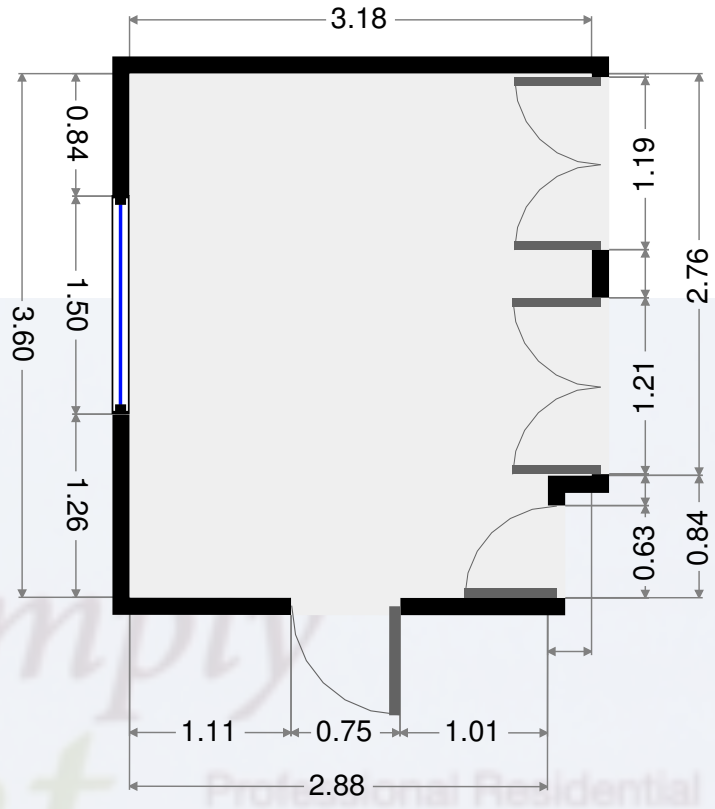
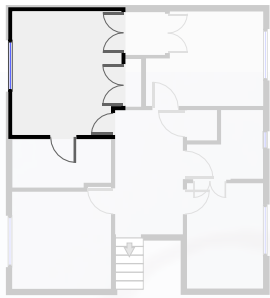

Bedroom

Width: 2.76 m Length: 3.42 m
 Area: 8 m² Perimeter: 12.35 m
 Ceiling Height: 2.60 m

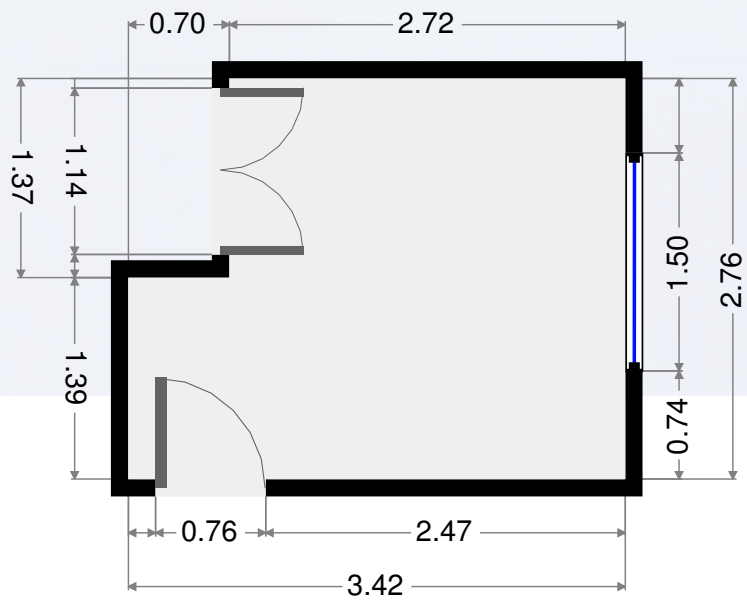
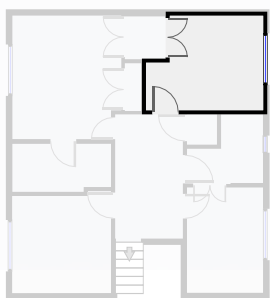

Although care has been taken in surveying the subjects for the production of this plan it's accuracy cannot be guaranteed and it should be regarded as indicative only and should not be relied upon for measuring purposes. Room contents and fittings are for illustration only and do represent the actual contents.

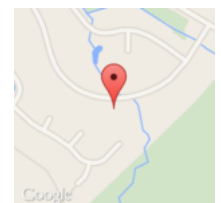

Bathroom

Width: 2.03 m Length: 2.22 m
 Area: 3 m² Perimeter: 8.49 m
 Ceiling Height: 2.60 m

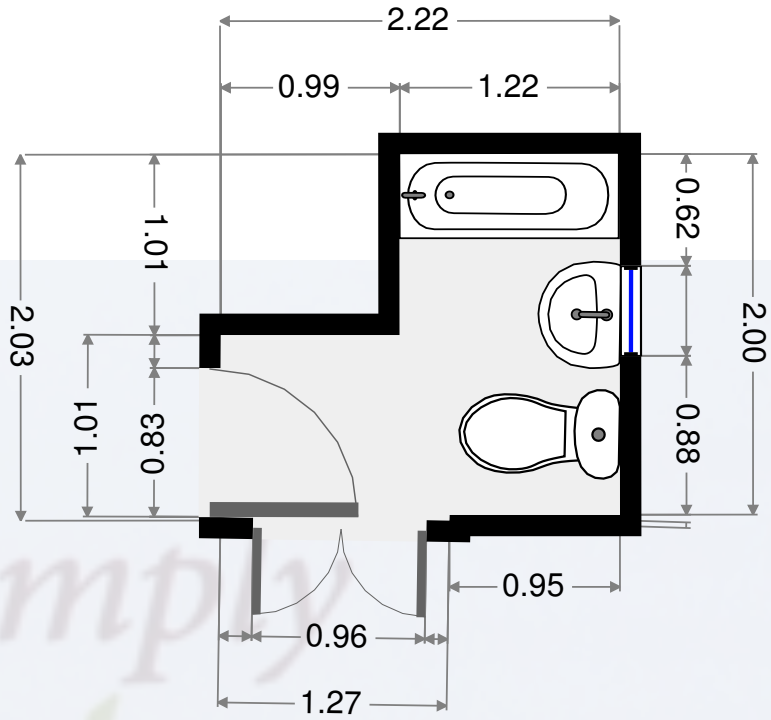
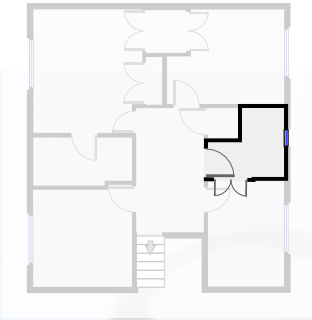

Bedroom

Width: 2.22 m Length: 3.07 m
 Area: 7 m² Perimeter: 10.59 m
 Ceiling Height: 2.60 m

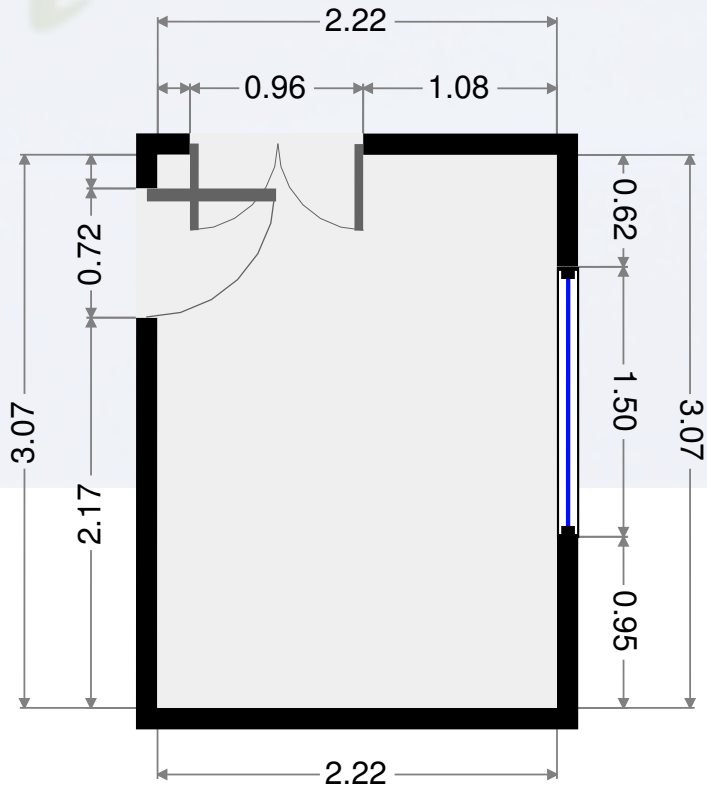
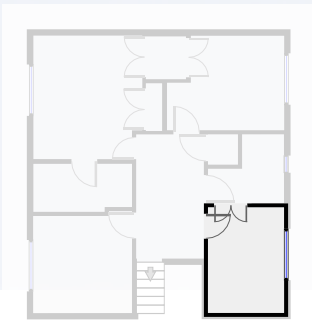

Although care has been taken in surveying the subjects for the production of this plan it's accuracy cannot be guaranteed and it should be regarded as indicative only and should not be relied upon for measuring purposes. Room contents and fittings are for illustration only and do represent the actual contents.



Plan 66

J R Gell MRICS
 john.gell@simplylet.biz
 01463 718888
 2014-10-21 11:58

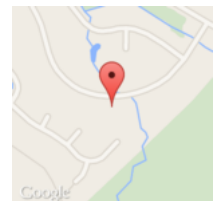

Closet

Width: 0.87 m Length: 0.88 m
Area: 1 m² Perimeter: 3.52 m

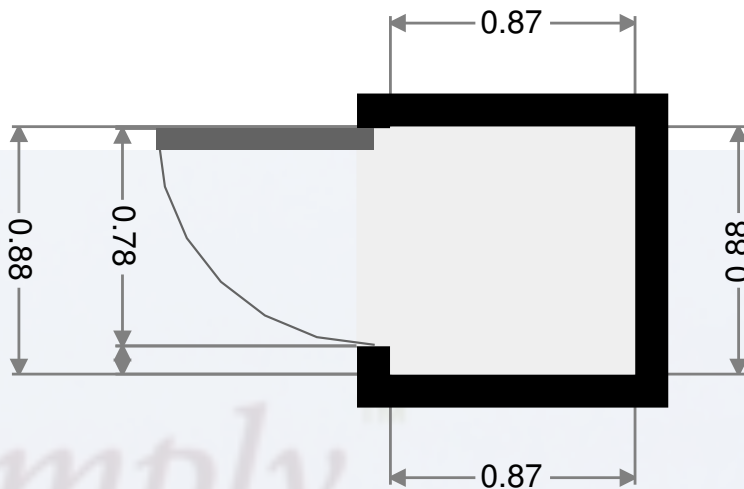
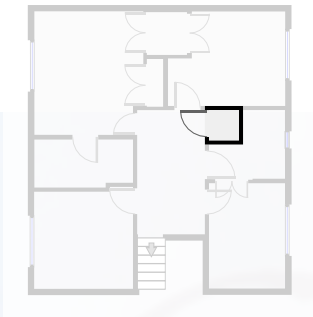

Closet

Width: 0.48 m Length: 1.39 m
Area: 1 m² Perimeter: 3.74 m

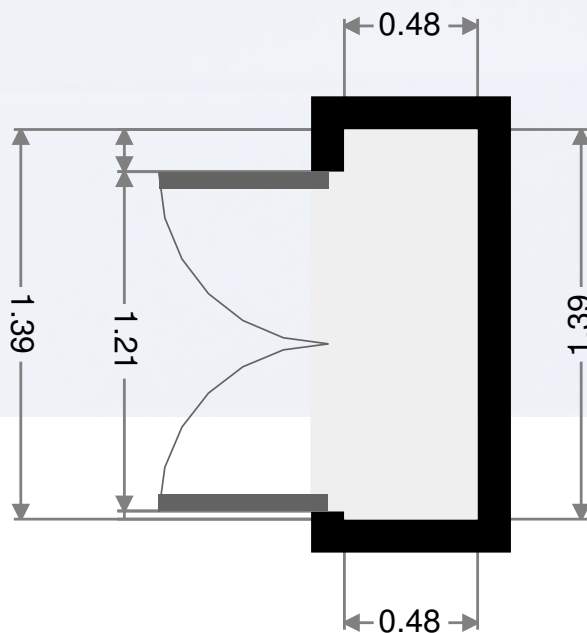
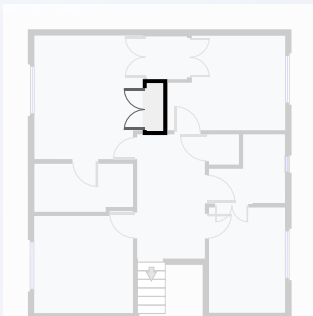

Simply Let
Professional Residential
Letting Specialists

Although care has been taken in surveying the subjects for the production of this plan it's accuracy cannot be guaranteed and it should be regarded as indicative only and should not be relied upon for measuring purposes. Room contents and fittings are for illustration only and do represent the actual contents.

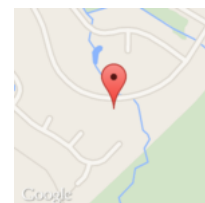

Closet

Width: 1.17 m Length: 1.25 m
Area: 1 m² Perimeter: 4.84 m

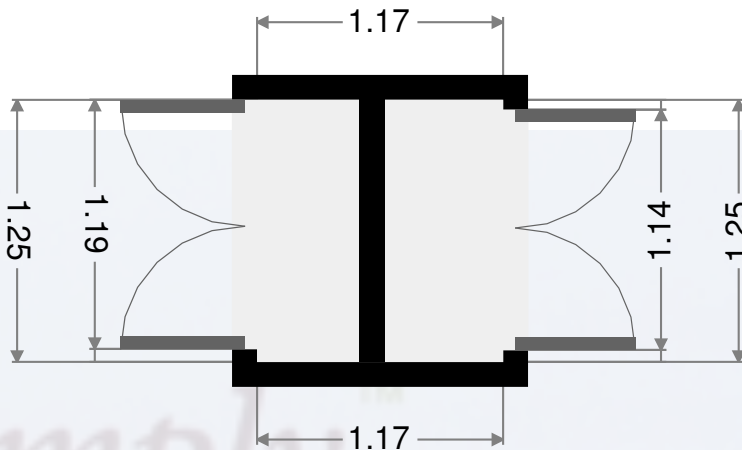
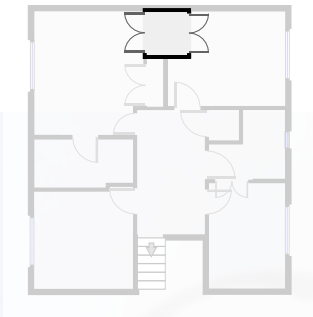

En-suite

Width: 1.40 m Length: 2.88 m
Area: 4 m² Perimeter: 8.56 m

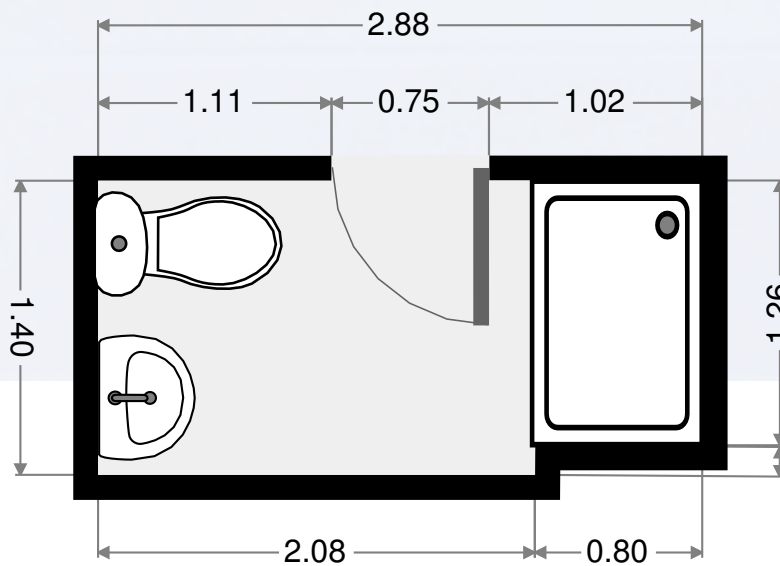
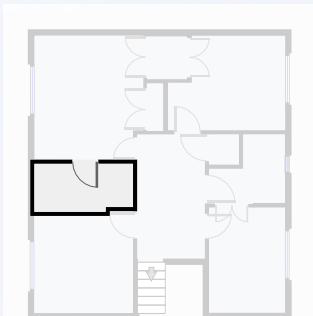

Although care has been taken in surveying the subjects for the production of this plan its accuracy cannot be guaranteed and it should be regarded as indicative only and should not be relied upon for measuring purposes. Room contents and fittings are for illustration only and do represent the actual contents.

